

UV LED SMD Type
SPECIFICATION

Model: NS400L-4SFH

Nitride Semiconductors Co., Ltd.

1. Name: UV LED LAMP SMD Type

2. Model: NS400L-4SFH

3. Absolute maximum ratings

Item	Symbol	Maximum rating	Unit
DC Forward current	I_F	100	mA
Power dissipation	P_D	840	mW
Operating temperature	T_{OPR}	-30 to +80	
Storage temperature	T_{STG}	-30 to +100	

4. Optical and electrical characteristics ($T_a=25$)

Item	Symbol	Condition	Min.	Typ.	Max.	Unit
Forward voltage	V_F	$I_F=80\text{mA}$	6.4	6.8	8.4	V
Peak wavelength*2	λ_p	$I_F=80\text{mA}$	400	-	405	nm
Full width at half maximum	λ	$I_F=80\text{mA}$	10	-	20	nm
Optical output power *3	P_o	$I_F=80\text{mA}$	-	150.0	-	mW

*2 Measurement error: $\pm 2\text{nm}$

*3 Measurement error: 10%

5. Standard optical and electrical characteristics

To be hereinafter described.

6. Dimensional outline and materials (This product complies with RoHS.)

To be hereinafter described.

7. Reliability

(1) Test items and the results

• Environmental test results

Test items	Test conditions	Notes	Test results
			Damages
Resistance to soldering heat (Reflow soldering)	Tsol=260±5 , 10 seconds	Two times	0/22
Solderability (Reflow soldering)	Tsol=235±5 , 5 seconds (using flux)	One time Wetting more than 95%	0/11

• Life test results

Test items	Test conditions	Notes	Test results
			Damages
Steady state operating life	Ta=25±2 , IF=100mA	1000 hours	0/2
Operating life at high temperature	Ta=80±2 , IF=40mA	1000 hours	0/2
Storage at high temperature	Ta=85±2	1000 hours	0/2
Operating life at low temperature	Ta= - 30 ± 2 , IF=40mA	1000 hours	0/2
Operating life at high temperature and humidity	Ta=60±2 , RH=90±5%, IF=40mA	500 hours	0/2
Storage at high temperature and humidity	Ta=60±2 , RH=90±5%	500 hours	0/2

(2) Criteria for judging damages

Test items	Symbols	Measurement conditions	Judgment criteria	
			Min.	Max.
Forward voltage	VF	IF=80mA	-	(U)×1.1
Optical output power	Po	IF=80mA	(L)×0.5	-

*(U): Upper standard level, (L): Lower standard level

8. Cautions

- (1) The LEDs emit very strong UV radiation. Do not look directly at the LEDs. UV radiation can harm your eyes. To prevent inadequate exposure of UV radiation, wear UV protective glasses.
- (2) The LEDs are very sensitive to static and surge. Take a full protection against static and surge.
- (3) The powered LEDs generate heat. Heat dissipation should be considered in the application design to avoid the environmental conditions for operation in excess of the absolute maximum ratings.
- (4) The LEDs should be kept at 30 °C or less and 60%RH or less and the LEDs should be soldered within 7 days after opening the package. If unused LEDs remain, they should be stored in moisture proof packages, such as sealed containers with packages of moisture absorbent material (silica gel).
- (5) The LEDs can be soldered in place using the reflow soldering method. Nitride Semiconductors Co., Ltd. cannot make a guarantee on the LEDs after they have been assembled using the dip soldering method. Please refer to the followings about the recommended soldering conditions.

Temperature profile

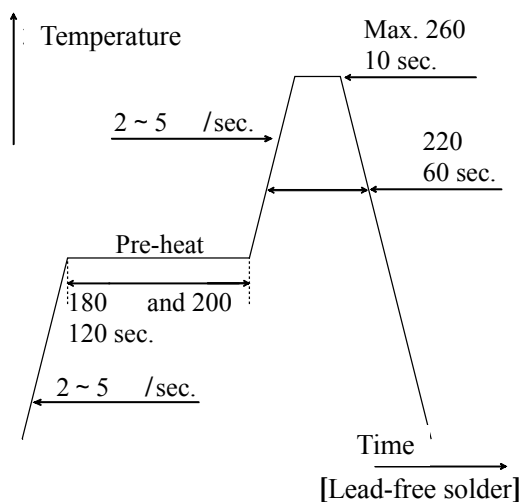

Recommended soldering pad design

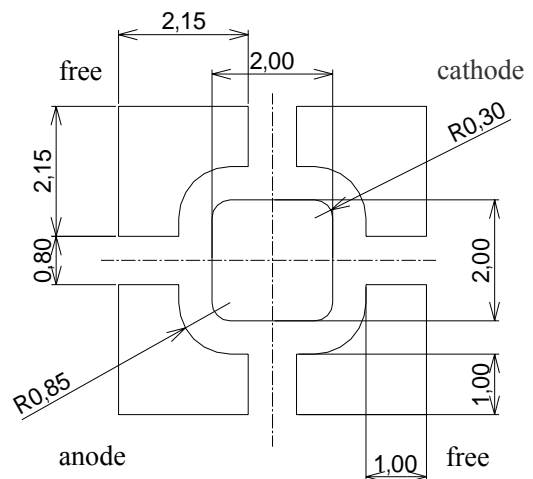

[Unit : mm]

The encapsulated material of the LEDs is silicone. Therefore, the LEDs have a soft surface on the top of package. The pressure to the top surface will be influence to the reliability of the LEDs. Precautions should be taken to avoid the strong pressure on the encapsulated part. So when using the chip mounter, the picking up nozzle that does not affect the silicone resin should be used.

Repairing should not be done after the LEDs have been soldered.

Reflow soldering should not be done more than two times.

When soldering, do not put stress on the LEDs during heating.

After soldering, do not warp the circuit board.

- (6) Do not clean the LEDs by the organic solvent. The organic solvent like acetone attached the surface of the LEDs may damage the package and the reliability of resin.
Do not also clean the LEDs by the ultrasonic.
- (7) The LEDs are intended to be used for ordinary electronics equipment. Do not use the LEDs for the applications that may require a higher reliability and security and that the failure or

malfunction of the LEDs may threaten life.

- (8) Do not reverse engineering by disassembling or analysis of the LEDs without our consent. If there's any defectives found, please contact our sales division.

9. Warranty

- (1) The warranty is valid for UV LED lamps only.
- (2) Perform an acceptance inspection on arrival of the goods. Return the defectives if any stipulating the disqualification and quantity.
- (3) Embedding the LEDs into the application and the verification of life and other qualities in practical use shall be executed by user.
- (4) Do not use the LEDs for the applications that require the higher reliability and security and that may endanger life and health by the breakdown and the malfunction. Seller shall not bear any responsibility or liability with respect to any claims and damages caused by user's usage of the LEDs without following our intended purpose or any written consent.
- (5) Seller shall not bear responsibility for any damages or defects caused by improper operation at the current in excess of the absolute maximum ratings that are not covered by warranty.

10. Miscellaneous

- (1) The electrode and the leads are gold plated. They may be changed in quality by exposing to the air contains corrosive gas. Be careful with the storage environment. The LEDs in the sealed bag can be stored for maximum 6 months. For the storage more than 6 months up to 1 year, the LEDs should be stored in the suitable environment of the stable temperature and humidity.
- (2) The technical information in this specification is not to guarantee the intellectual property rights of seller's nor a third party and not to grant the license.
- (3) The appearance and specifications are subject to change for improvement without prior notice.

Optical and electrical characteristics

Forward voltage vs. Forward current

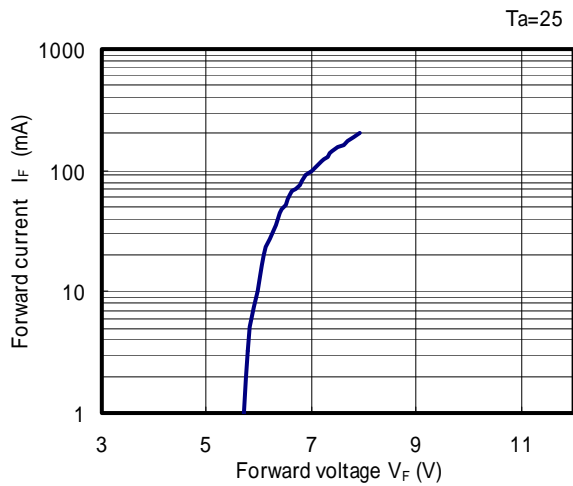

Forward current vs. Relative output power

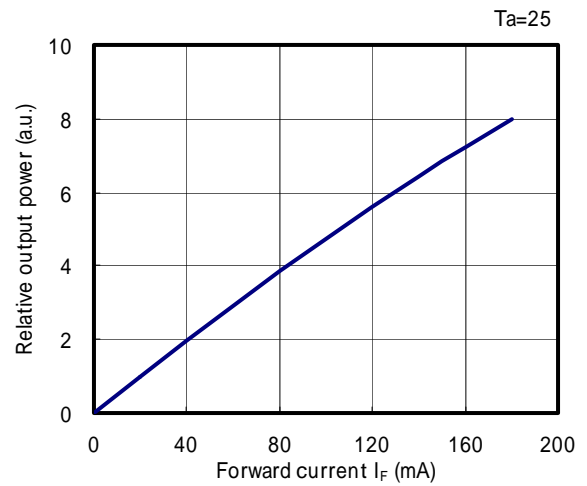

Ambient temperature vs. Relative output power

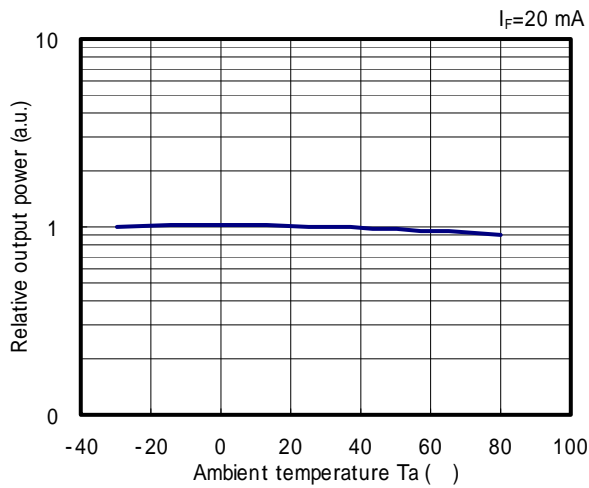

Ambient temperature vs. Forward voltage

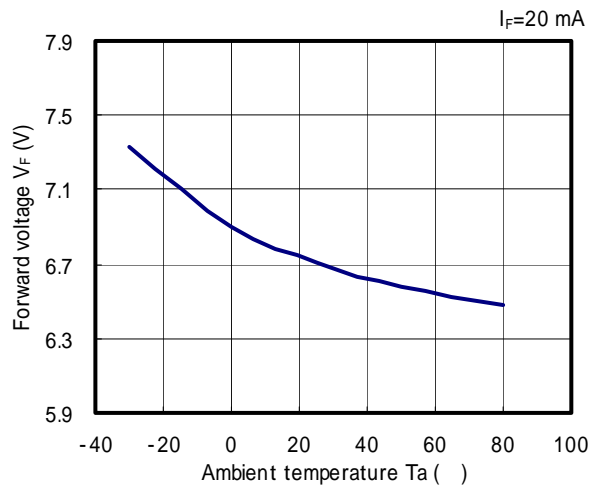

Ambient temperature vs.
Allowable forward current

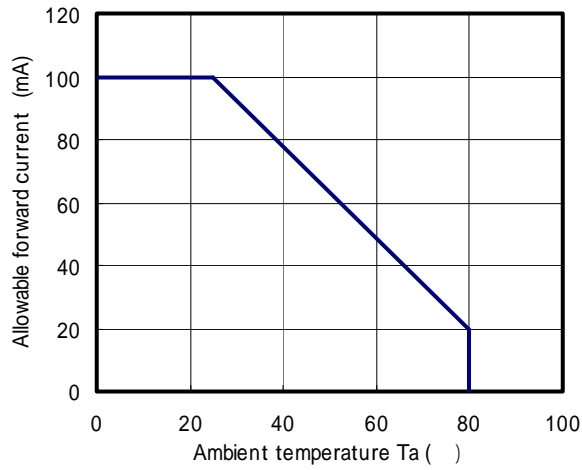

Spectrum

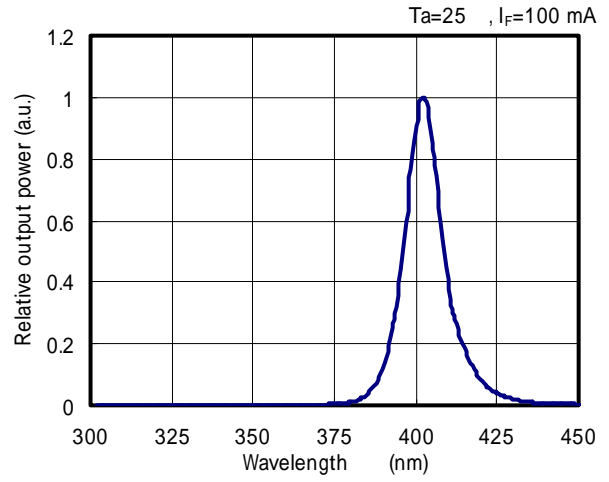

Directivity

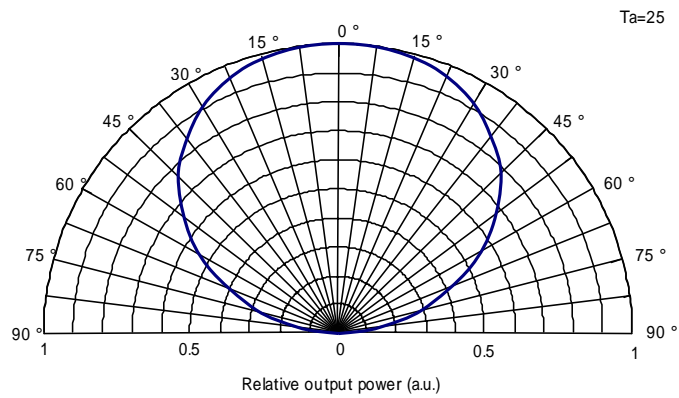

Dimensional outline drawing

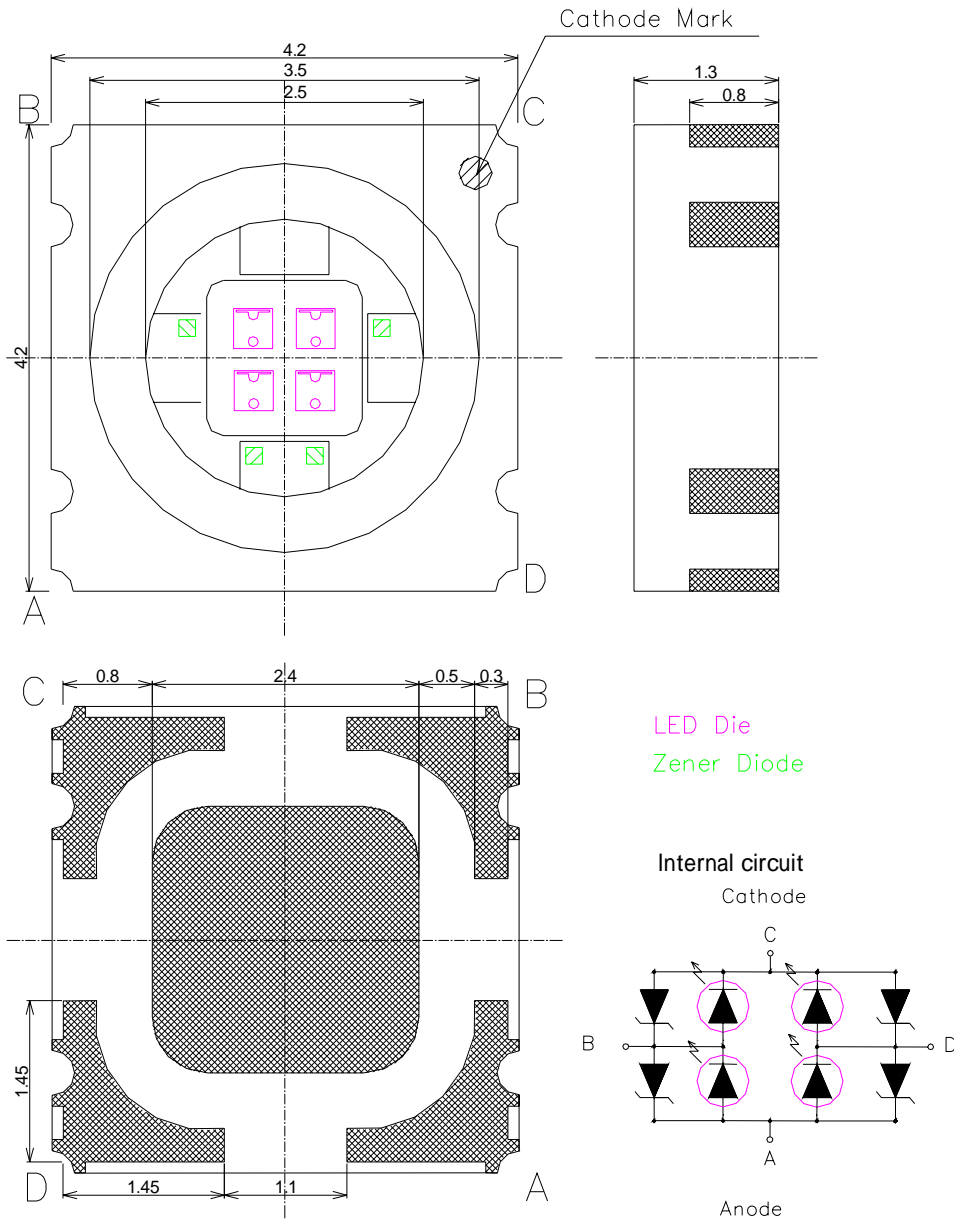

(Unit : mm)

*A zener diode is built in the protective circuit against static electricity.

Item	Material
Package	Ceramics
Encapsulating Resin	Silicone resin
Electrodes	AuPd

Reel part

Closeup of reel center hole

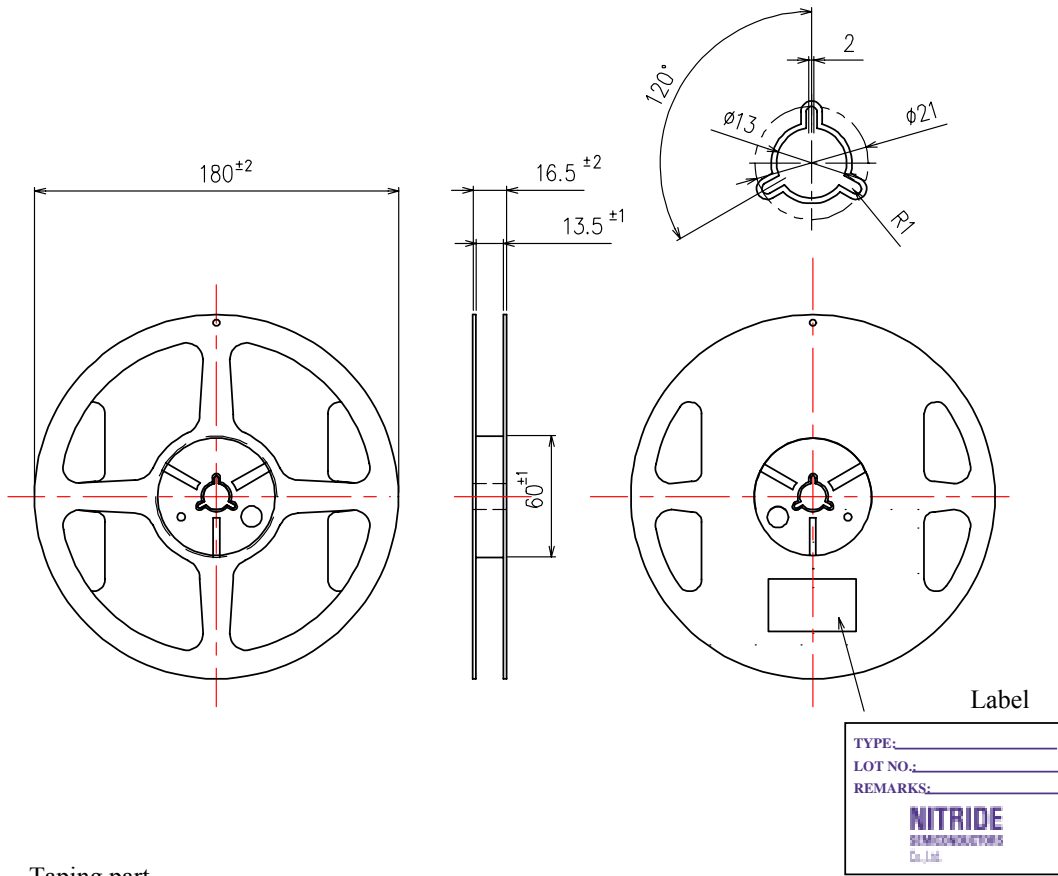

Taping part

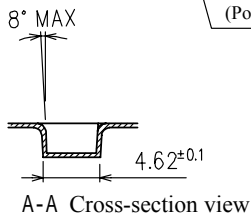
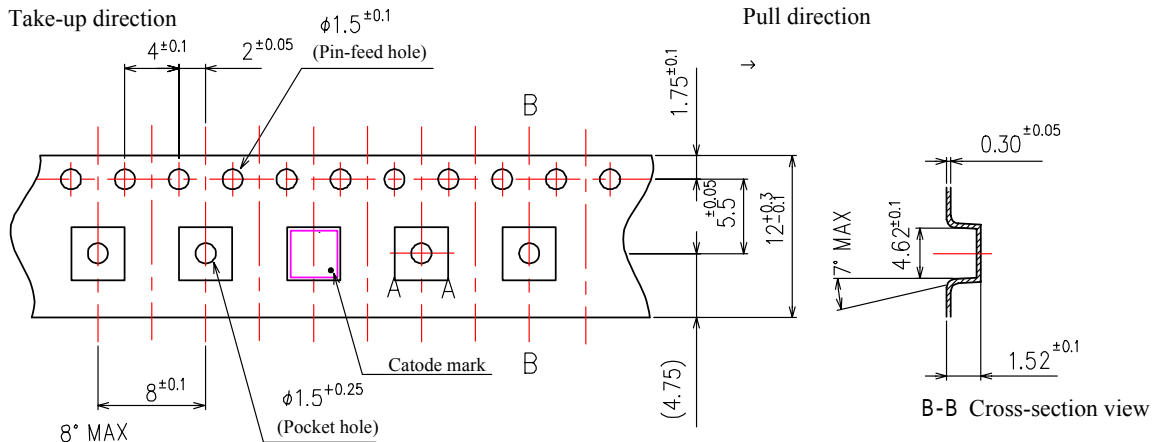

1,500 pcs/Reel
 Embossed carrier tape : 12 mm in width
 Pitch : 8.0 mm
 Top cover tape : 9.5 mm in width
 Reel lead : approx. 15 pcs of pocket hole (No LEDs) in pull direction
 approx. 33 pcs of pocket hole (No LEDs) in take-up direction

(Unit : mm)

NS400L-4SFH
100201-NS