

UV LED LAMP SPECIFICATION

Model: NS375L-5CFA

Nitride Semiconductors Co., Ltd.

1. Name: UV LED LAMP

2. Model: NS375L-5CFA

3. Absolute maximum ratings

| Item | Symbol | Maximum rating | Unit |
|-------------------------|-----------|-----------------------|------|
| DC forward current | I_F | 25 | mA |
| Pulse forward current*1 | I_{FP} | 100 | mA |
| Power dissipation | P_D | 100 | mW |
| Operating temperature | T_{OPR} | -30 to +80 | |
| Storage temperature | T_{STG} | -30 to +100 | |
| Soldering temperature | T_{SOL} | 260 within 10 seconds | |

*1 Conditions: duty cycle 1/10, pulse width 0.1msec

4. Optical and electrical characteristics ($T_a=25$)

| Item | Symbol | Condition | Min. | Typ. | Max. | Unit | |
|----------------------------|-------------|------------|------------|------|------|------|----|
| Forward voltage | V_F | $I_F=20mA$ | 3.2 | 3.6 | 4.2 | V | |
| Peak wavelength*2 | λ_p | $I_F=20mA$ | 375 | - | 380 | nm | |
| Full width at half maximum | λ | $I_F=20mA$ | - | 12 | - | nm | |
| Optical output power *3 | Rank 4 | $P_o.$ | $I_F=20mA$ | 0.8 | - | 1.2 | mW |
| | Rank 5 | | | 1.2 | - | 1.8 | mW |
| | Rank 6 | | | 1.8 | - | 2.4 | mW |
| | Rank 7 | | | 2.4 | - | 3.0 | mW |

*2 Measurement error: $\pm 2nm$

*3 Measurement error: 10%

5. Standard optical and electrical characteristics

See the attached.

6. Configuration and materials (This product complies with RoHS.)

See the attached.

7. Reliability

(1) Test items and the results

• Mechanical test results

| Test items | Test conditions | Notes | Test results | |
|-------------------------------------|---|---------------------|--------------|---------|
| | | | LTPD | Damages |
| Terminal strength (pulling/pushing) | Load 5N (pulling) Load 1N(pushing) | For 10 seconds each | 50% | 0/5 |
| Terminal strength (bending) | Load 2.5N 0°to 90°to 0° to reverse direction 90°to 0° | One time | 50% | 0/5 |
| Dropping damage | Dropping from 1m high | Two times | 20% | 0/11 |

• Environmental test results

| Test items | Test conditions | Notes | Test results | |
|------------------------------|--|-----------------------------------|--------------|---------|
| | | | LTPD | Damages |
| Resistance to soldering heat | $T_{SOL}=260\pm 5$,10 seconds At 1.5mm from the lead base | One time | 10% | 0/22 |
| Resistance to soldering heat | $T_{SOL}=350\pm 5$, 3 seconds At 1.5mm from the lead base | One time | 10% | 0/22 |
| Solderability | $T_{SOL}=230\pm 5$, 5 seconds (using flux) | One time Wetting more than 95% | 20% | 0/11 |
| Thermal shock | Lower than -30 (antifreeze fluid) to higher than 95 (boiling water) for 5 minutes each | 10 cycles | 10% | 0/22 |

• Life test results

| Test items | Test conditions | Notes | Test results | |
|---|--|------------|--------------|---------|
| | | | LTPD | Damages |
| Steady state operating life | $T_a=25\pm 2$, $I_F=25mA$ | 1000 hours | 10% | 0/22 |
| Operating life at high temperature | $T_a=80\pm 2$, $I_F=10mA$ | 1000 hours | 10% | 0/22 |
| Storage at high temperature | $T_a=100\pm 2$ | 1000 hours | 10% | 0/22 |
| Operating life at low temperature | $T_a=-30\pm 2$, $I_F=15mA$ | 1000 hours | 10% | 0/22 |
| Operating life at high temperature and humidity | $T_a=60\pm 2$, $RH=90\pm 5\%$, $I_F=15mA$ | 500 hours | 10% | 0/22 |
| Storage at high temperature and humidity | $T_a=60\pm 2$, $RH=90\pm 5\%$ | 1000 hours | 10% | 0/22 |

(2) Criteria for judging damages

| Test items | Symbols | Measurement conditions | Judgment criteria | |
|----------------------|---------|------------------------|-------------------|---------|
| | | | Min. | Max. |
| Forward voltage | V_F | $I_F=20mA$ | - | (U)×1.1 |
| Optical output power | P_o | $I_F=20mA$ | (L)×0.5 | - |

*(U): Upper standard level, (L): Lower standard level

8. Cautions

- (1) The LEDs emit very strong UV radiation. Do not look directly at the LEDs. UV radiation can harm your eyes. To prevent inadequate exposure of UV radiation, wear UV protective glasses.
- (2) The LEDs are very sensitive to static and surge. Take a full protection against static and surge.
- (3) The powered LEDs generate heat. Heat dissipation should be considered in the application design to avoid the environmental conditions for operation in excess of the absolute maximum ratings.
- (4) The leads should be bent at minimum 1.5mm away from the base of header. The LEDs should be soldered at minimum 3mm away from the base of header.
- (5) The LEDs are intended to be used for ordinary electronics equipment. Do not use the LEDs for the applications that may require a higher reliability and security and that the failure or malfunction of the LEDs may threaten life.
- (6) Do not reverse engineering by disassembling or analysis of the LEDs without our consent. If there's any defectives found, please contact our sales division.

9. Warranty

- (1) The warranty is valid for UV LED lamps only.
- (2) Perform an acceptance inspection on arrival of the goods. Return the defectives if any stipulating the disqualification and quantity.
- (3) Embedding the LEDs into the application and the verification of life and other qualities in practical use shall be executed by user.
- (4) Do not use the LEDs for the applications that require the higher reliability and security and that may endanger life and health by the breakdown and the malfunction. Seller shall not bear any responsibility or liability with respect to any claims and damages caused by user's usage of the LEDs without following our intended purpose or any written consent.
- (5) Seller shall not bear responsibility for any damages or defects caused by improper operation at the current in excess of the absolute maximum ratings that are not covered by warranty.

10. Miscellaneous

- (1) The leads are gold plated. They may be changed in quality by exposing to the air contains corrosive gas. Be careful with the storage environment. The LEDs in the sealed bag can be stored for maximum 6 months. For the storage more than 6 months up to 1 year, the LEDs should be stored in the suitable environment of the stable temperature and humidity.
- (2) The technical information in this specification is not to guarantee the intellectual property rights of seller's nor a third party and not to grant the license.
- (3) The appearance and specifications are subject to change for improvement without prior notice.

Optical and electrical characteristics

Forward voltage vs. Forward current

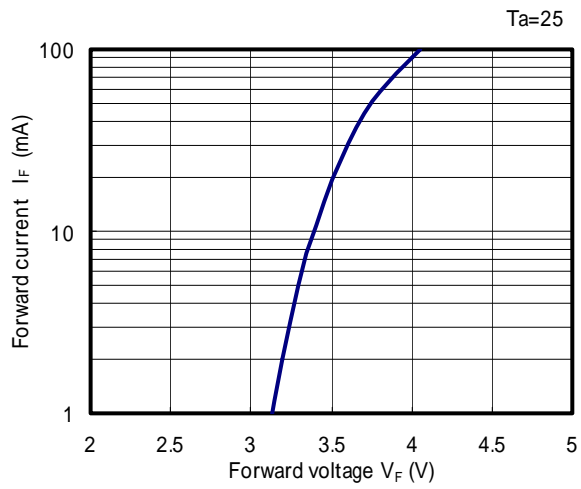

Forward current vs. Relative output power

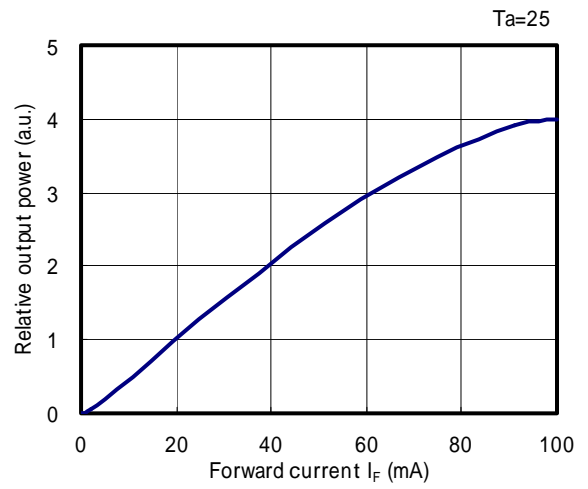

Ambient temperature vs. Relative output power

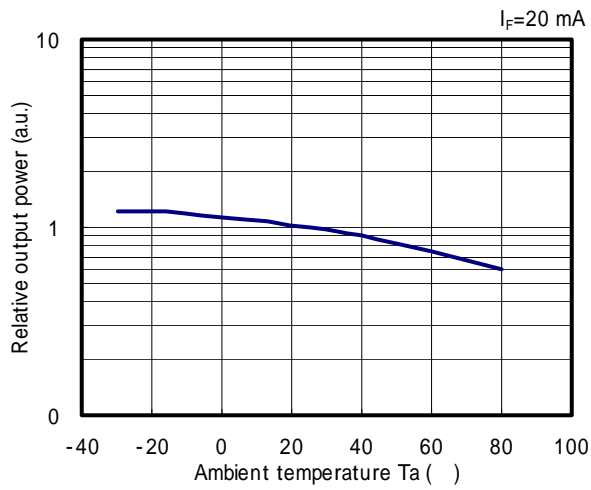

Ambient temperature vs. Forward voltage

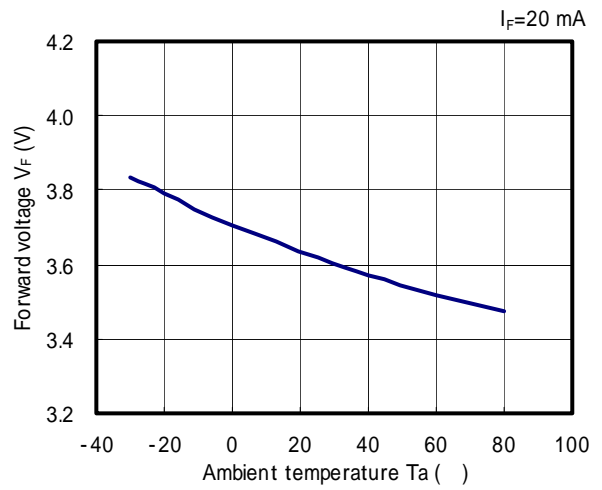

Ambient temperature vs.
Allowable forward current

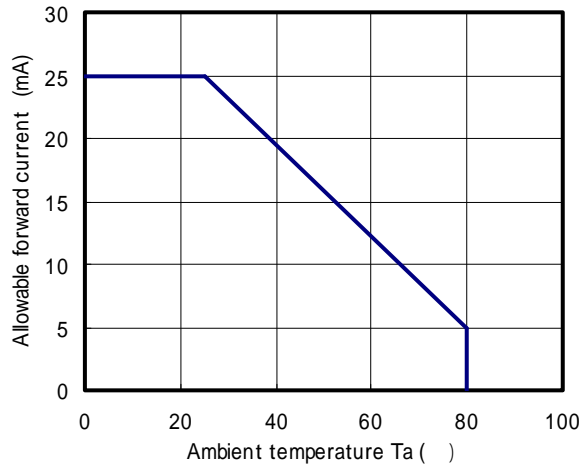

Spectrum

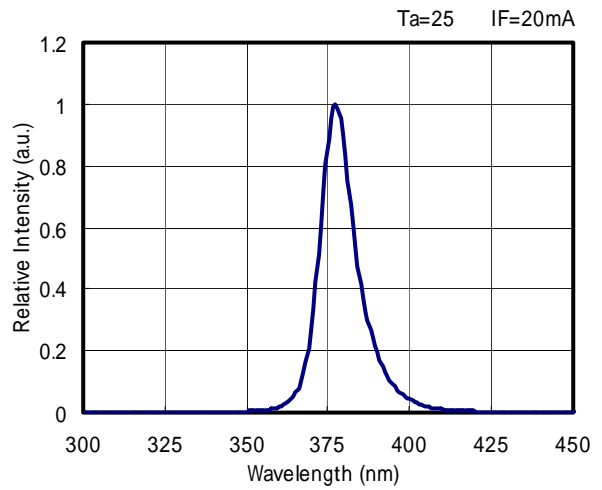

Ambient temperature vs. Peak wavelength

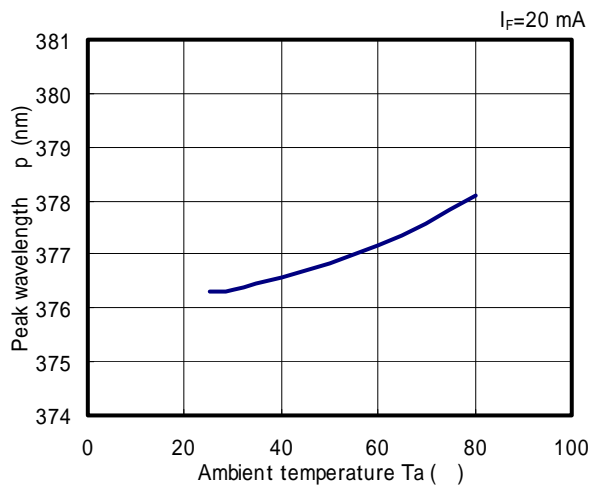

Directivity

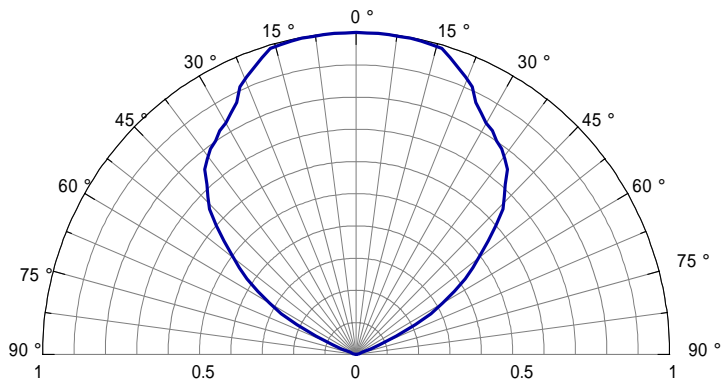

Dimensional outline drawing

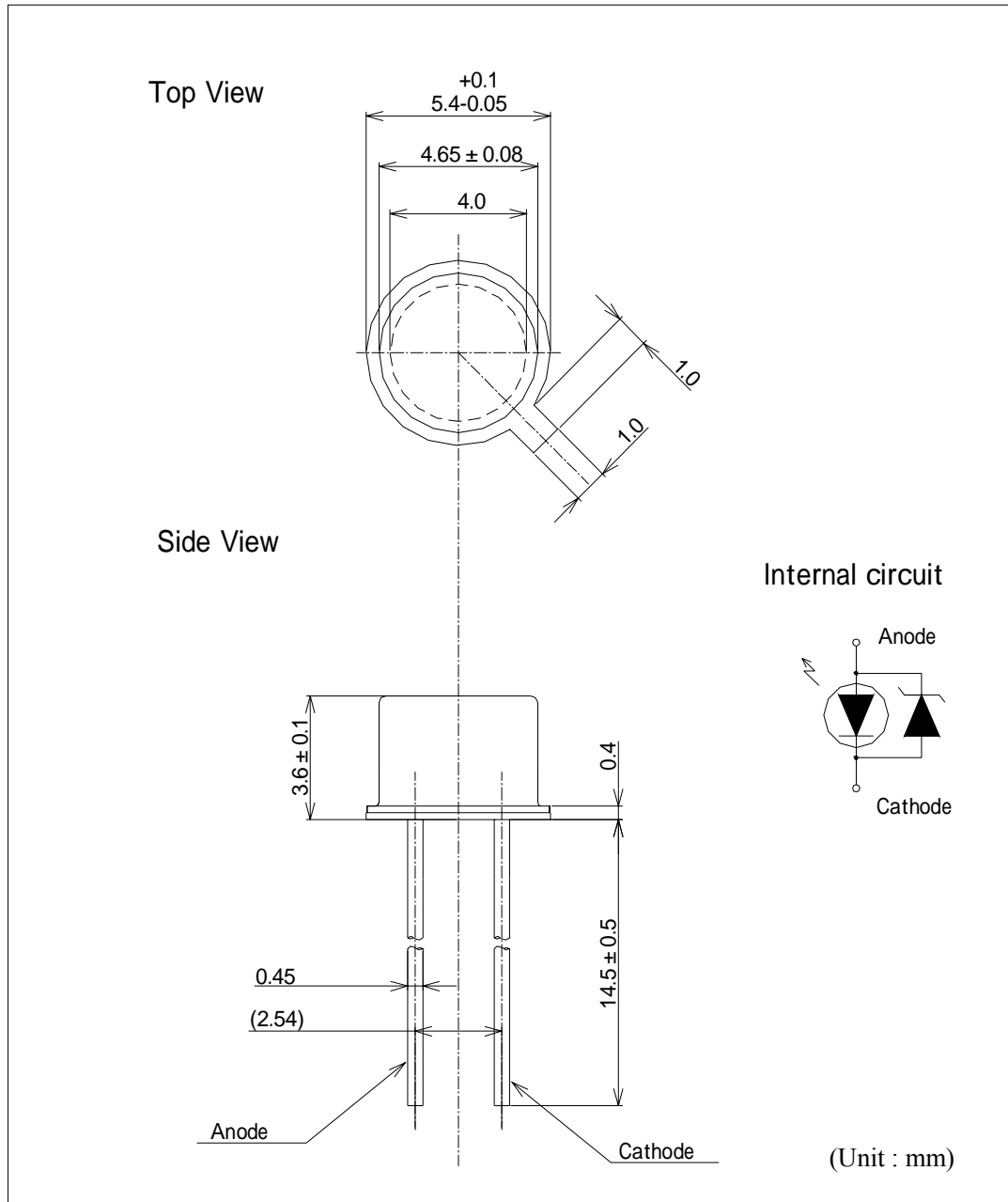

*A zener diode is built in the protective circuit against static electricity.

| | Material |
|------------|----------------------|
| Glass lens | Hard glass |
| Header | Ni-plated iron alloy |
| Lead | Au-plated iron alloy |